



East Midtown Greenway

53RD TO 61ST STREET

Community Board 6 Meeting

January 28, 2019

NYCEDC



NYC Parks



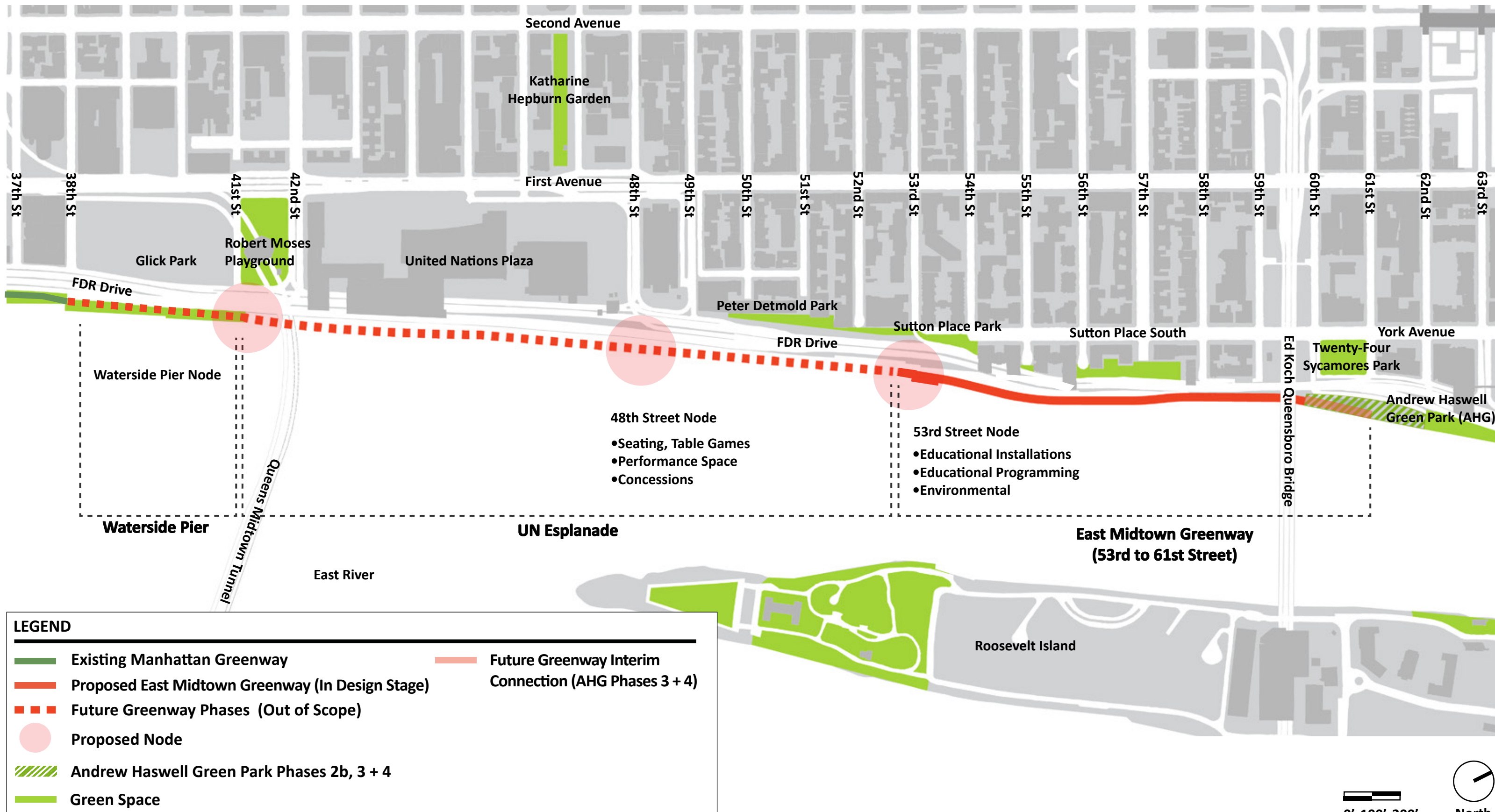

LEGEND

	Existing Manhattan Greenway		Future Greenway Interim Connection (AHG Phases 3 + 4)
	Proposed East Midtown Greenway (In Design Stage)		Proposed Node
	Future Greenway Phases (Out of Scope)		Andrew Haswell Green Park Phases 2b, 3 + 4
	Green Space		



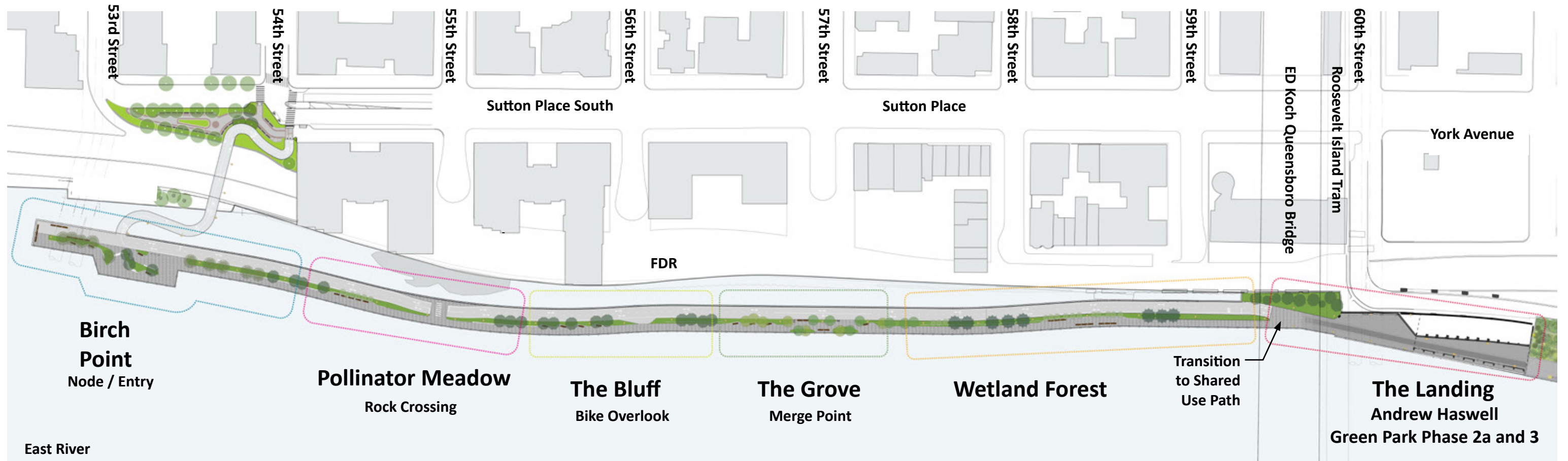

NODE DESIGN: EDUCATIONAL OPPORTUNITIES

- Educational signage
- Group gathering
- Photo opportunities

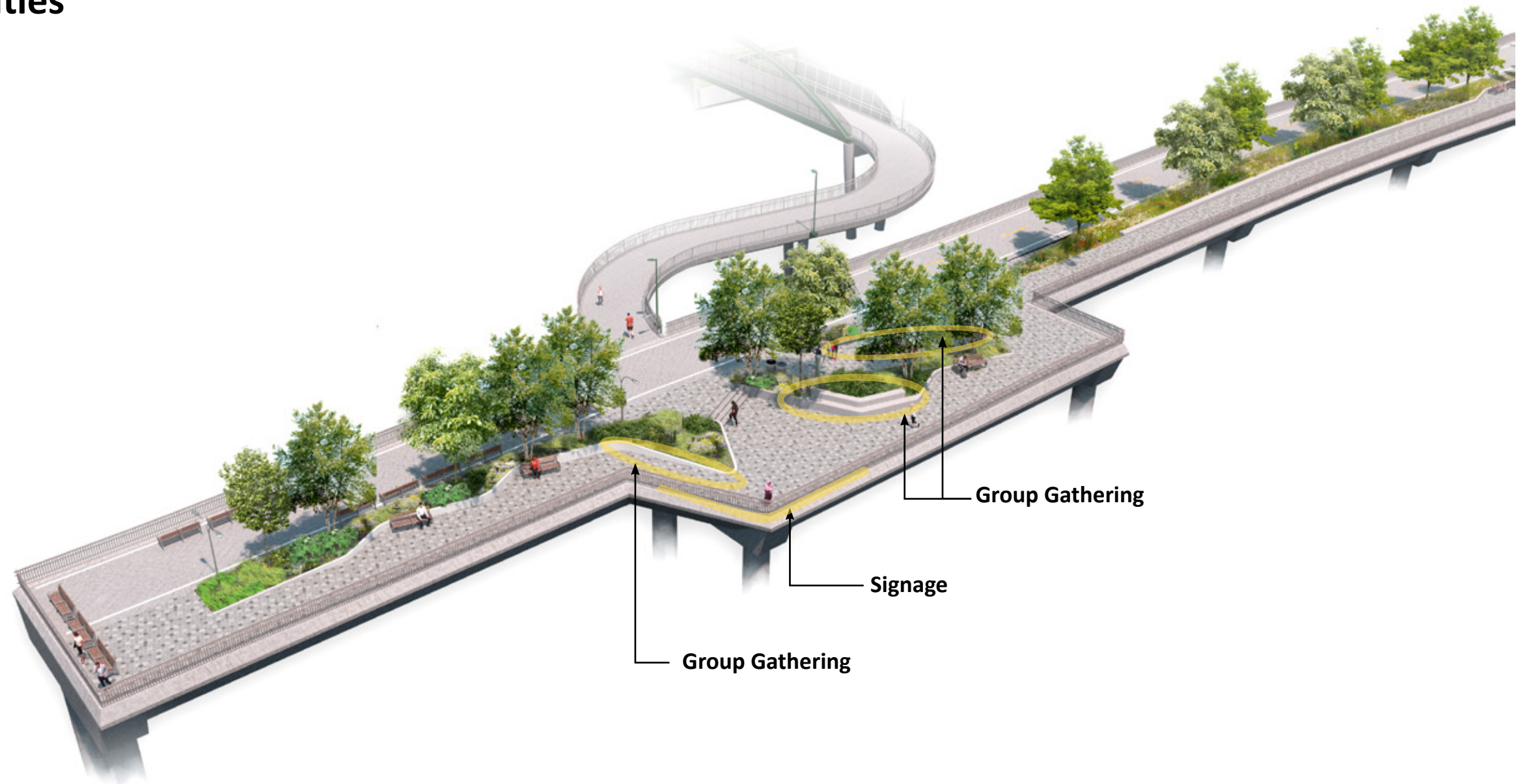

PAVING & STRUCTURES

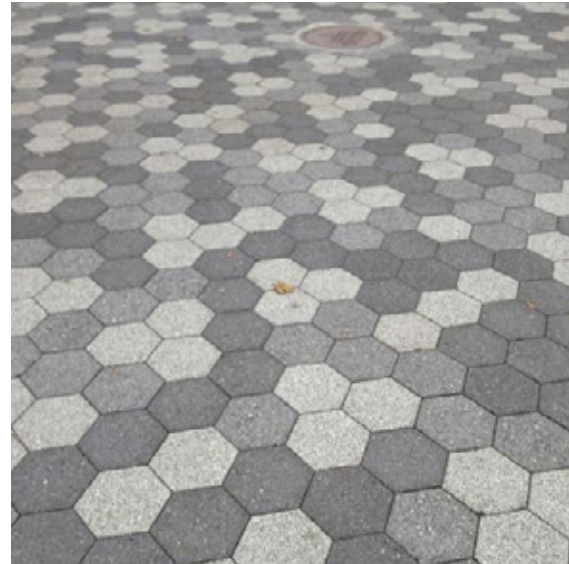

8" Hexagon Concrete Pavers
Color: Light Gray, Medium Gray, Dark Gray

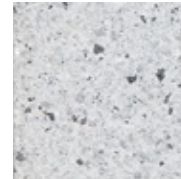

Wausau Tile, 8" Hexagon Concrete Pavers, XP-10

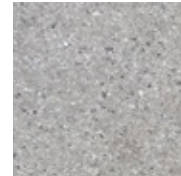

Wausau Tile, 8" Hexagon Concrete Pavers, UF-35

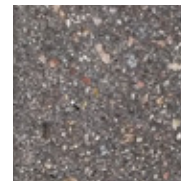

Wausau Tile, 8" Hexagon Concrete Pavers, UF-60

Bikeway Concrete
Color: Non-pigmented



Planter Wall
Material: Precast Concrete
Color: White
Finish: Light Sandblast
Mfr.: BPDL

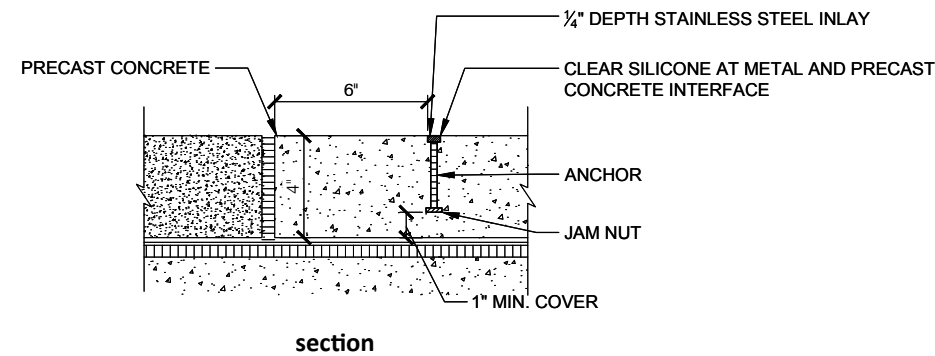

Street Identification Pavement
Material: Precast Concrete Street with Stainless Steel Inlay
Precast Concrete Color: Dark Grey

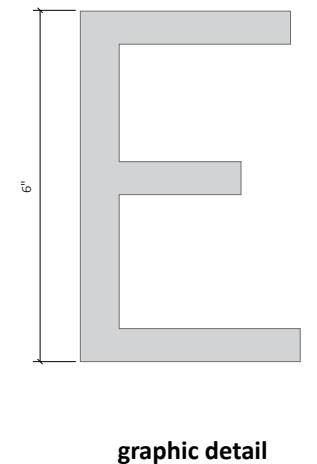



Aerial View (looking Northwest)



Looking north near 54th Street



Looking north under the Ed Koch Queensboro Bridge

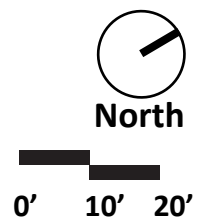
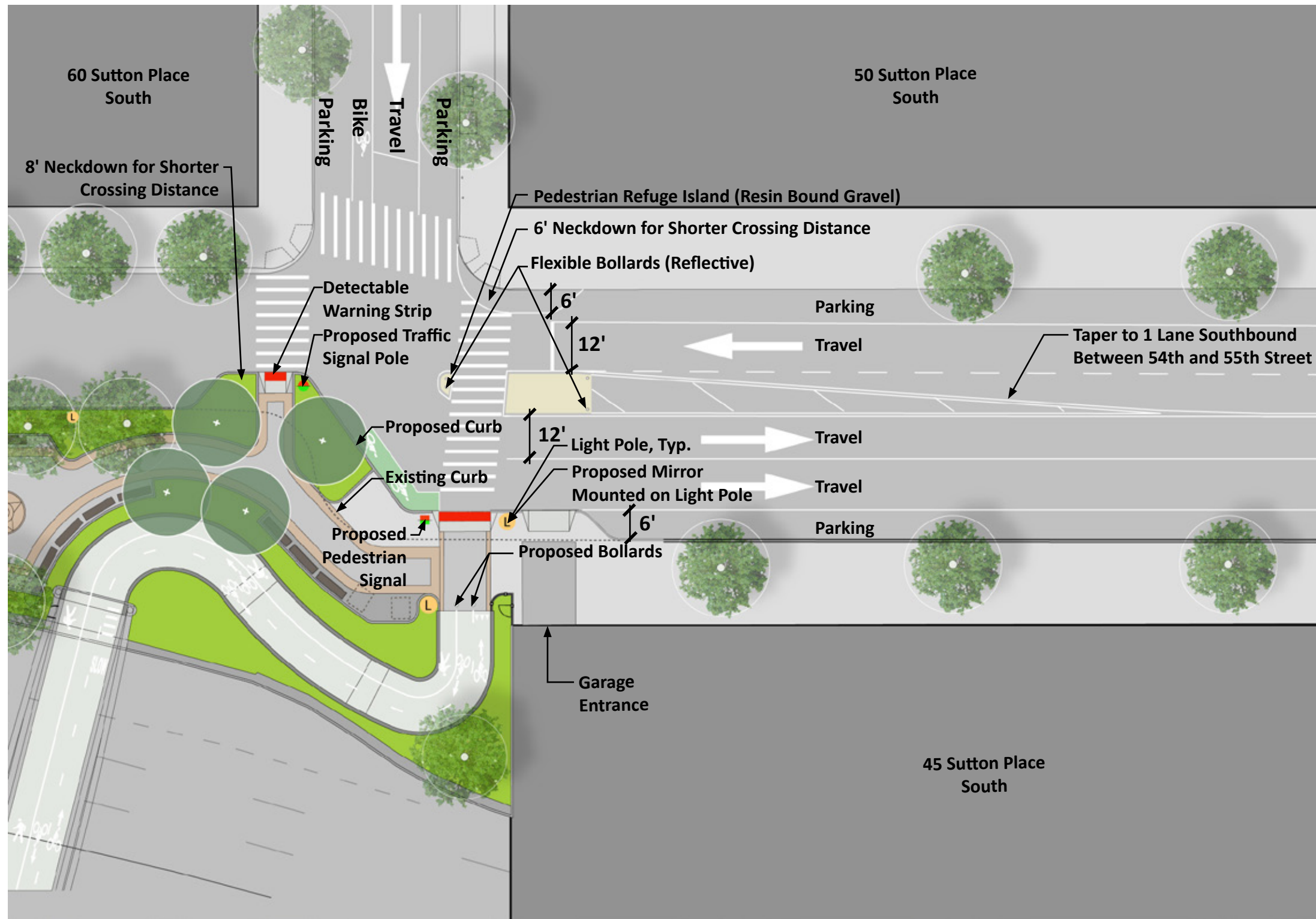

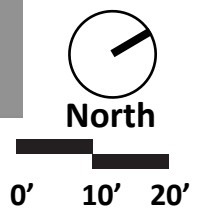
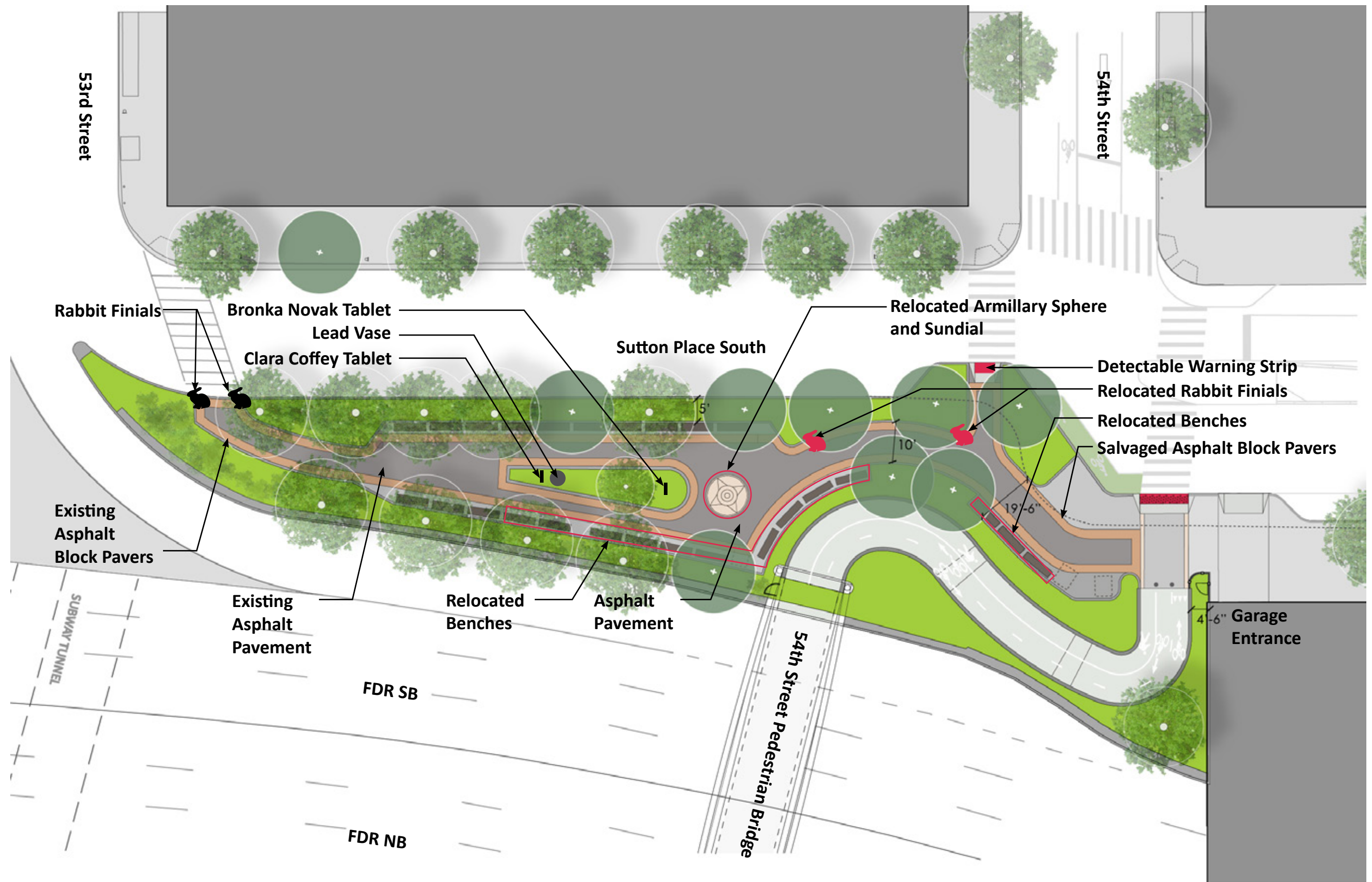



Looking east at 54th Street and Sutton Place Park South



Looking north in Sutton Place Park

Public Art Goals

- **Integrate into the proposed design.**
- **Reflect the significance of this project.**
- **Consider the natural environment and community contexts.**
- **Support the many uses of the space.**
- **Comply with NYC agency standards.**



River Return
San Antonio River Walk Mission Reach,
San Antonio Texas



River Return
San Antonio River Walk Mission Reach,
San Antonio, Texas



River Return
San Antonio River Walk Mission Reach,
San Antonio, Texas



Topo Map for School Avenue
Fayetteville, Arkansas



Topo Map for School Avenue
Fayetteville, Arkansas



Street Lagoon
Philadelphia, PA



Lotic Meander
Ontario Science Centre, Toronto, Canada



Ridge and Valley
Penn State Arboretum, University Park, PA



Writing on Pavement
Line striping paint on asphalt



Cornerstones
Eastlake Avenue at Lake Union, Seattle, WA



Cornerstones
Eastlake Avenue at Lake Union, Seattle, WA



Cornerstones
Eastlake Avenue at Lake Union, Seattle, WA

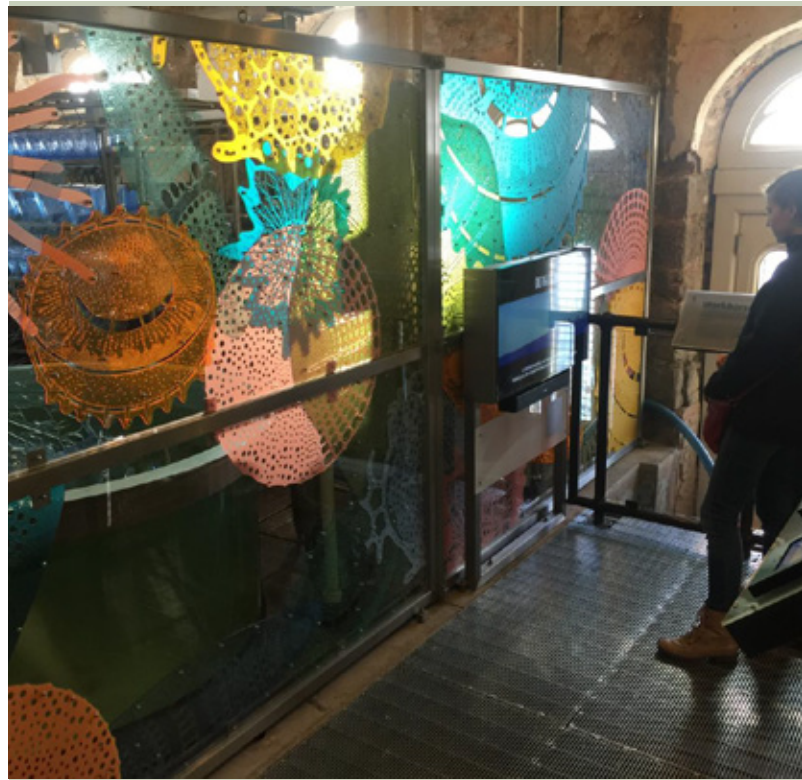

Diatom Lace
Freshwater Mussel Hatchery
Fairmount Waterworks, Philadelphia, PA



Glass Flash Cards: The rivers food web
sandblasted into glass.



Mold Garden
sharing the unexpected beauty of the microscopic
natural world that may seem scary or gross until it
is viewed close up

Inspiration for the project: In every spoonful of brackish water: a myriad of Diatoms in many shapes and designs

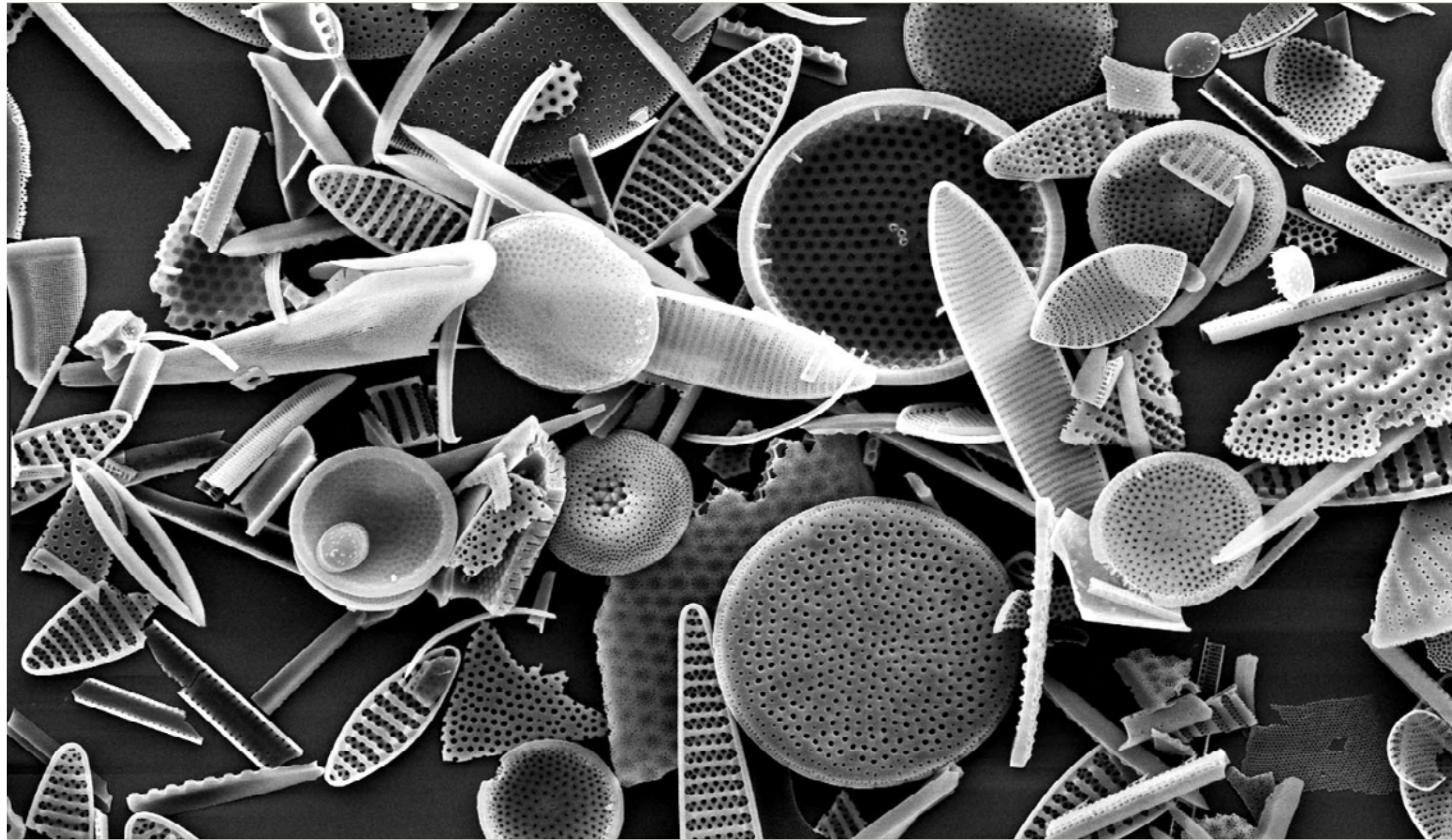

Getting to know who lives in the East River: researching the diatoms of this particular waterway and translating their forms into art

Diatoms are microscopic algae that are present in all waterways from freshwater ponds to all the oceans. They make their shells of silica in the water, creating ornate “glass houses” around their cell protoplasm. Diatoms are the base of the food chain and provide the energy for all the other creatures in the river. Their invisible presence is essential to the health of all waterways. This artwork introduces the park visitors to their invisible neighbors.

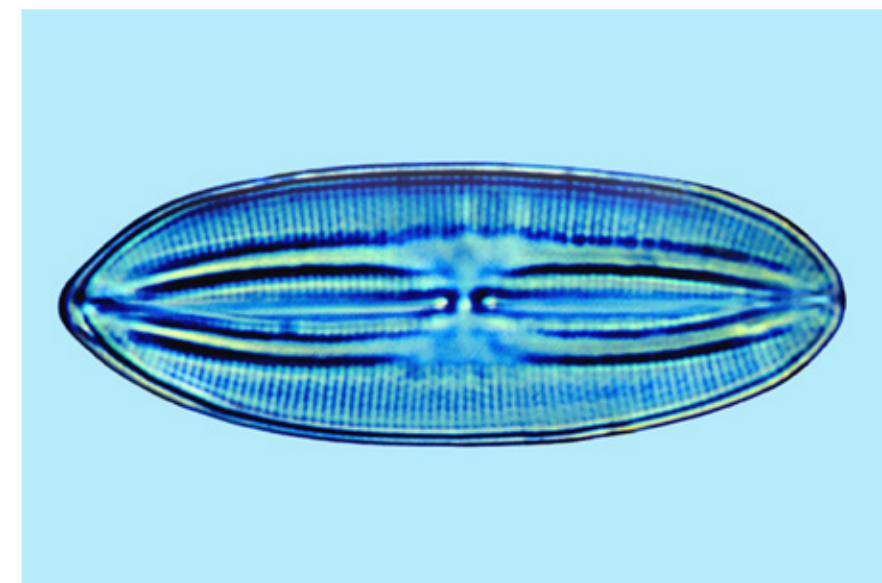
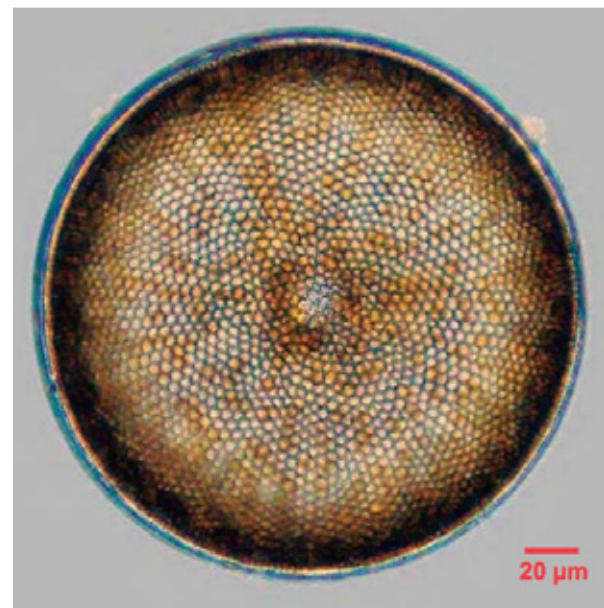
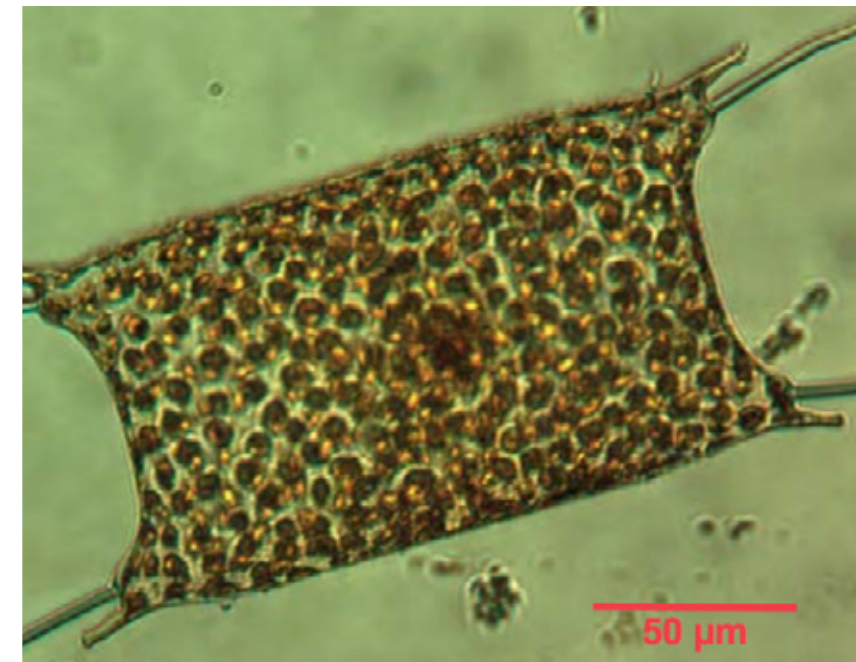
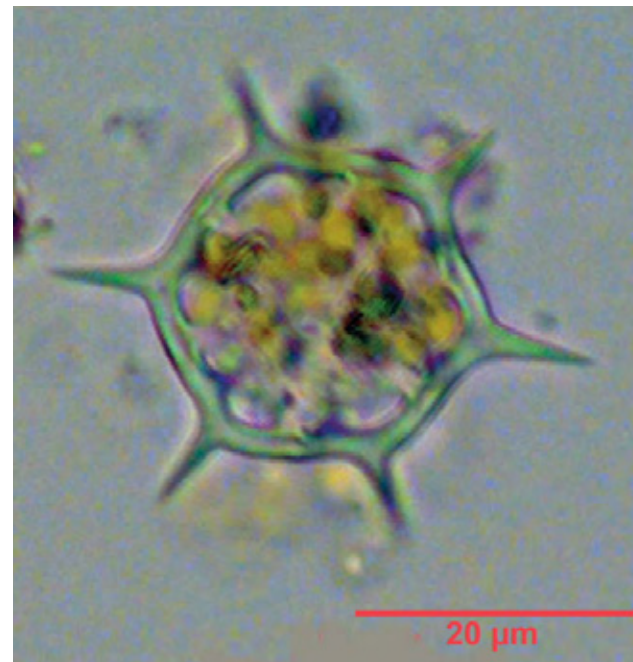

Taking actual images of these beautiful single celled algae microorganisms from the East River

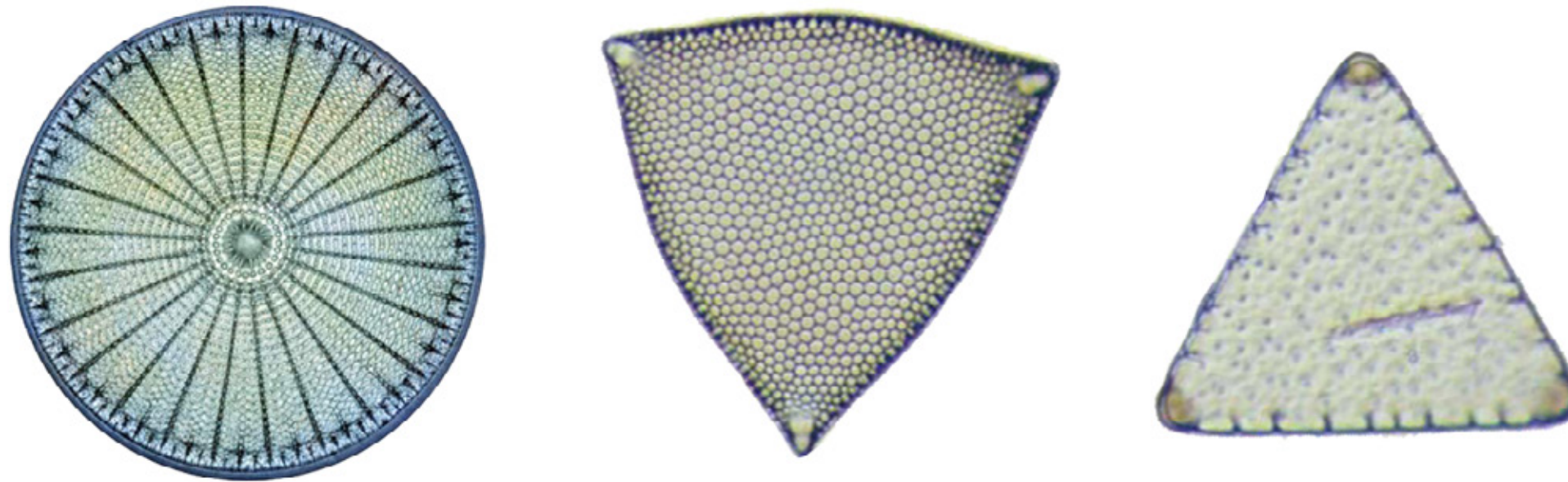

Designing a hex paver using the local diatoms from the East River as the pattern

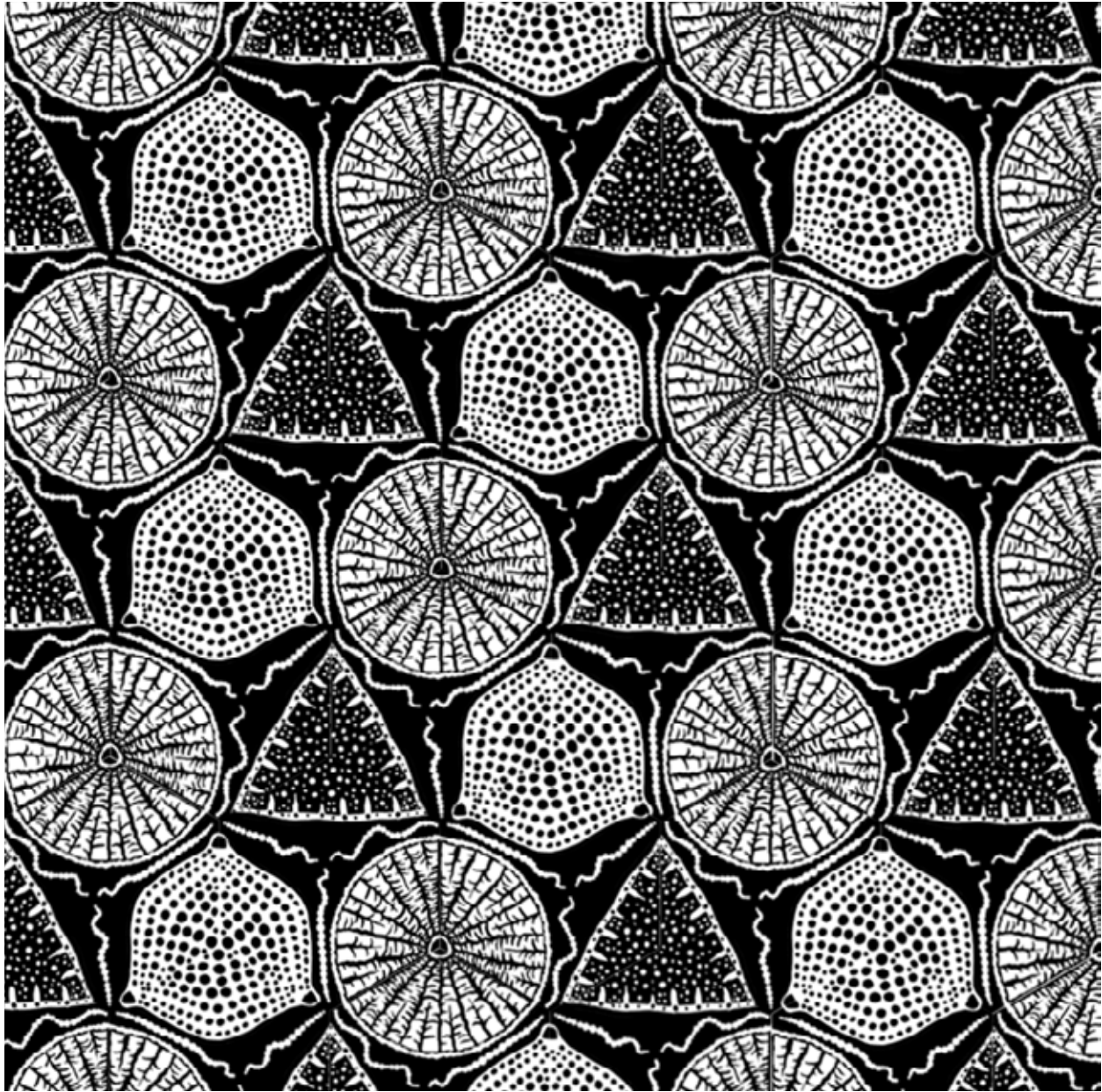

Creating a pattern that can be cast into the concrete hex paver and set into the park's floor



Inspiration: GAUDI TILE (PANOTS) Passeig de Gracia, Barcelona, Spain
Fantastical marine creatures make a repeating patterns in cast concrete hex pavers.
You know where you are when this pattern is underfoot.



Possible layout of the paver zones in the park

Primarily in the node plus medallions at the Rock Crossing, Bike Overlook, and Merge Point, and AHG Transition

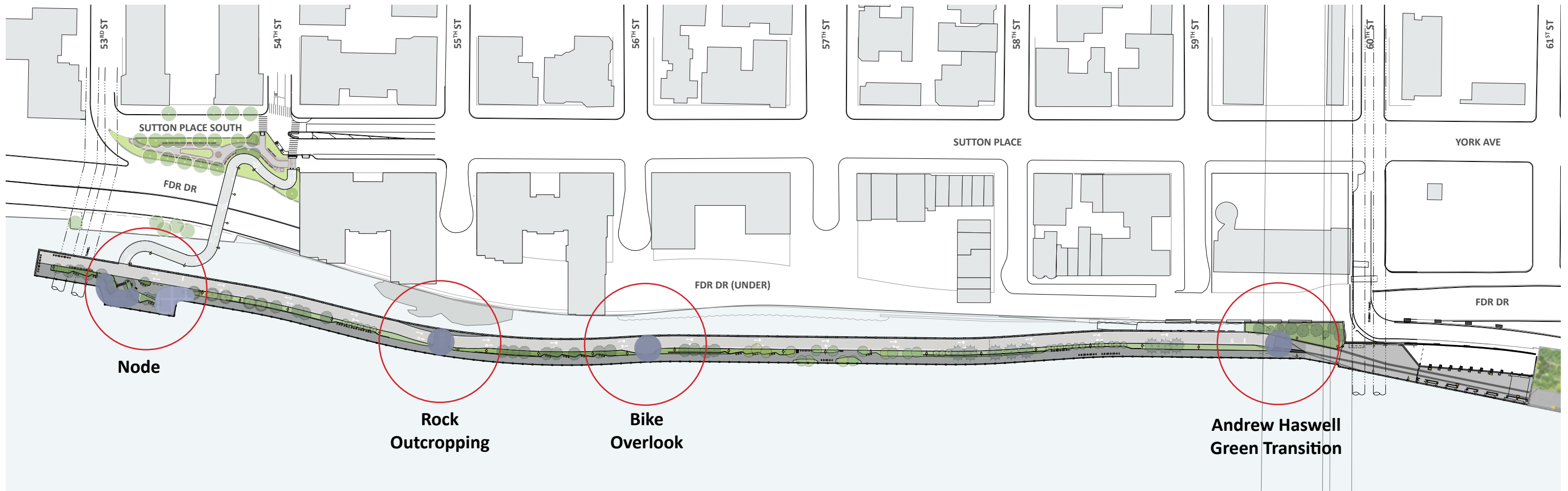

Plan showing a cluster pattern option for the Node



0' 20' 40'



A single paver cast or carved

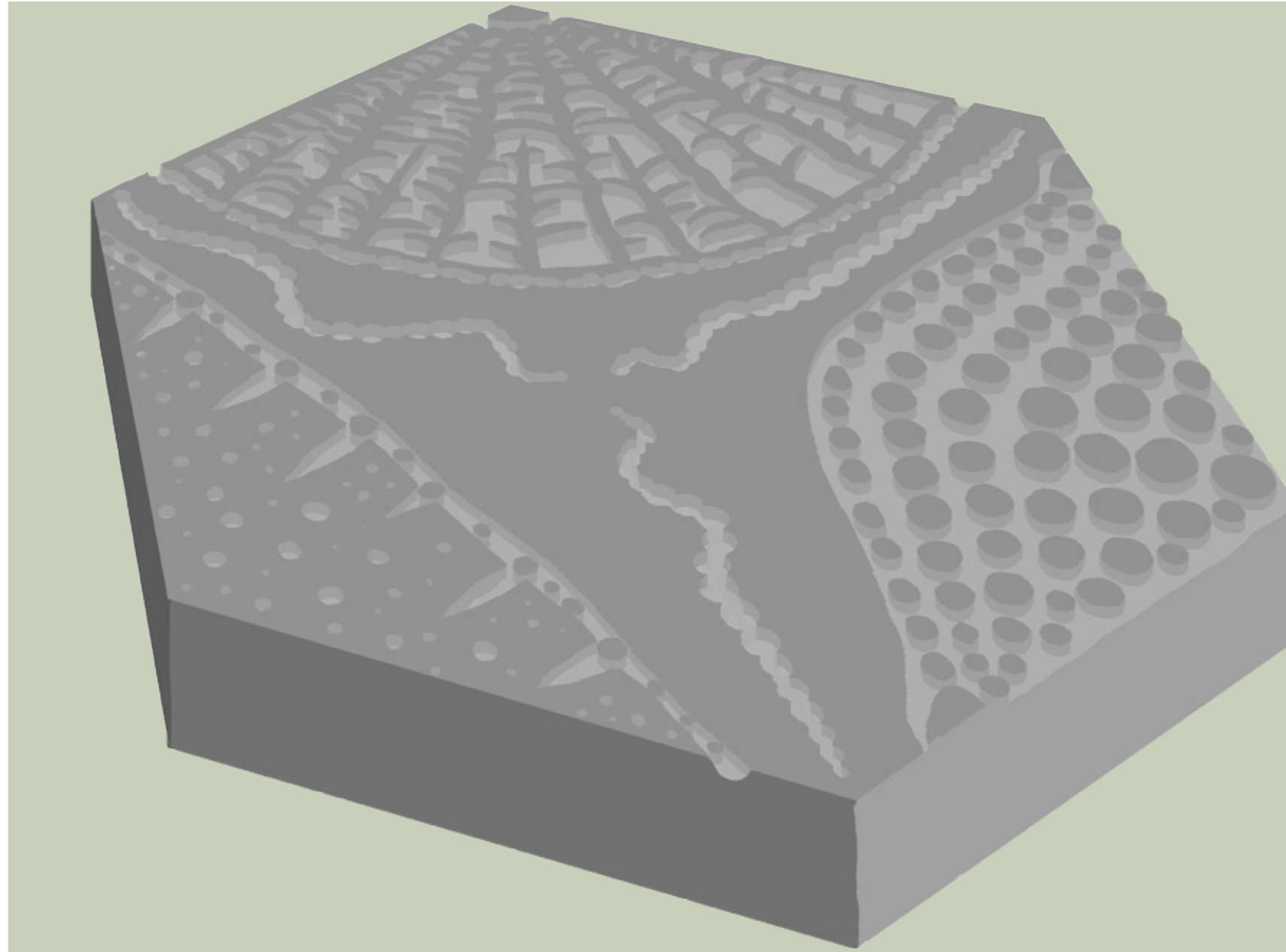
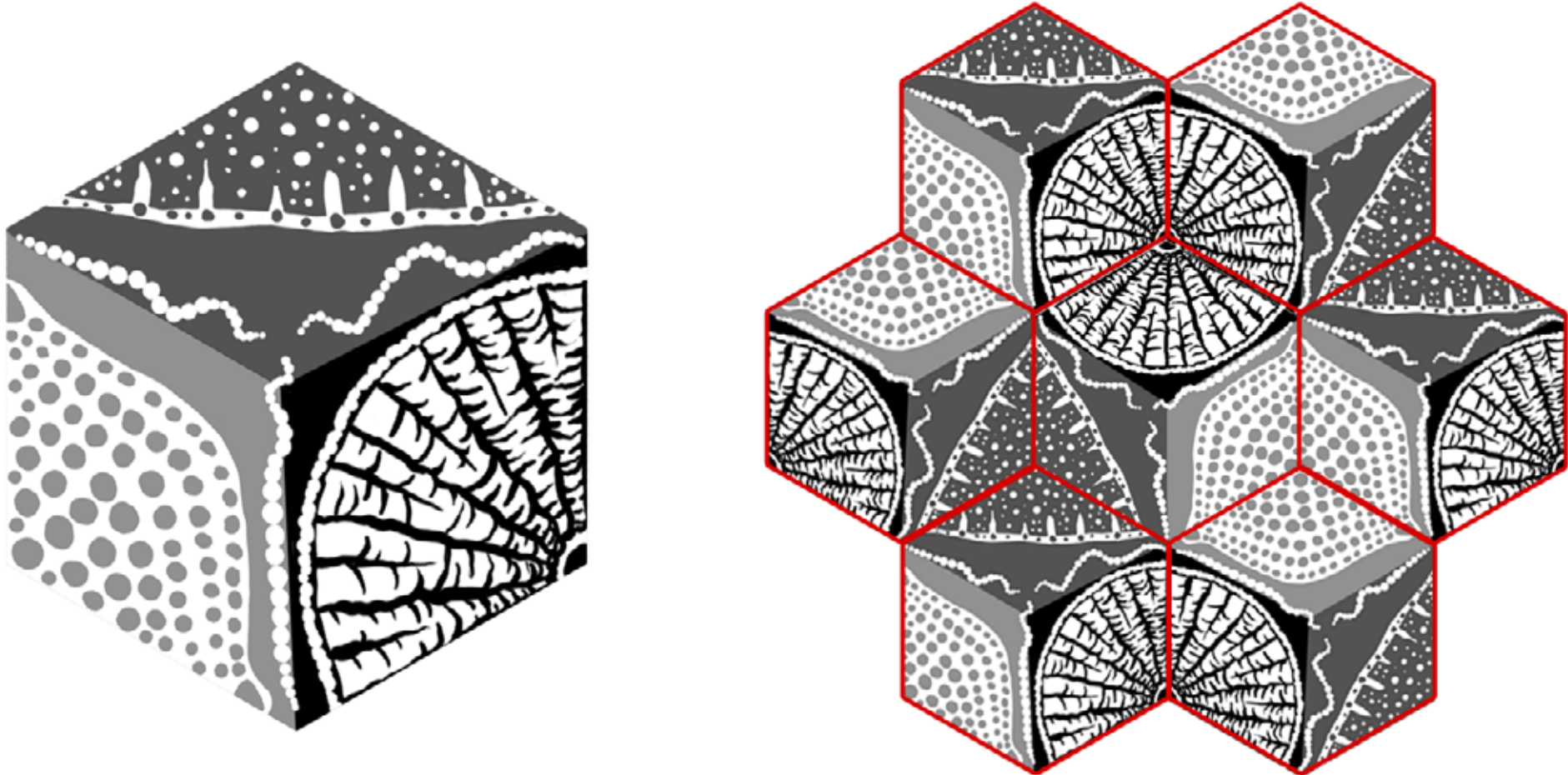
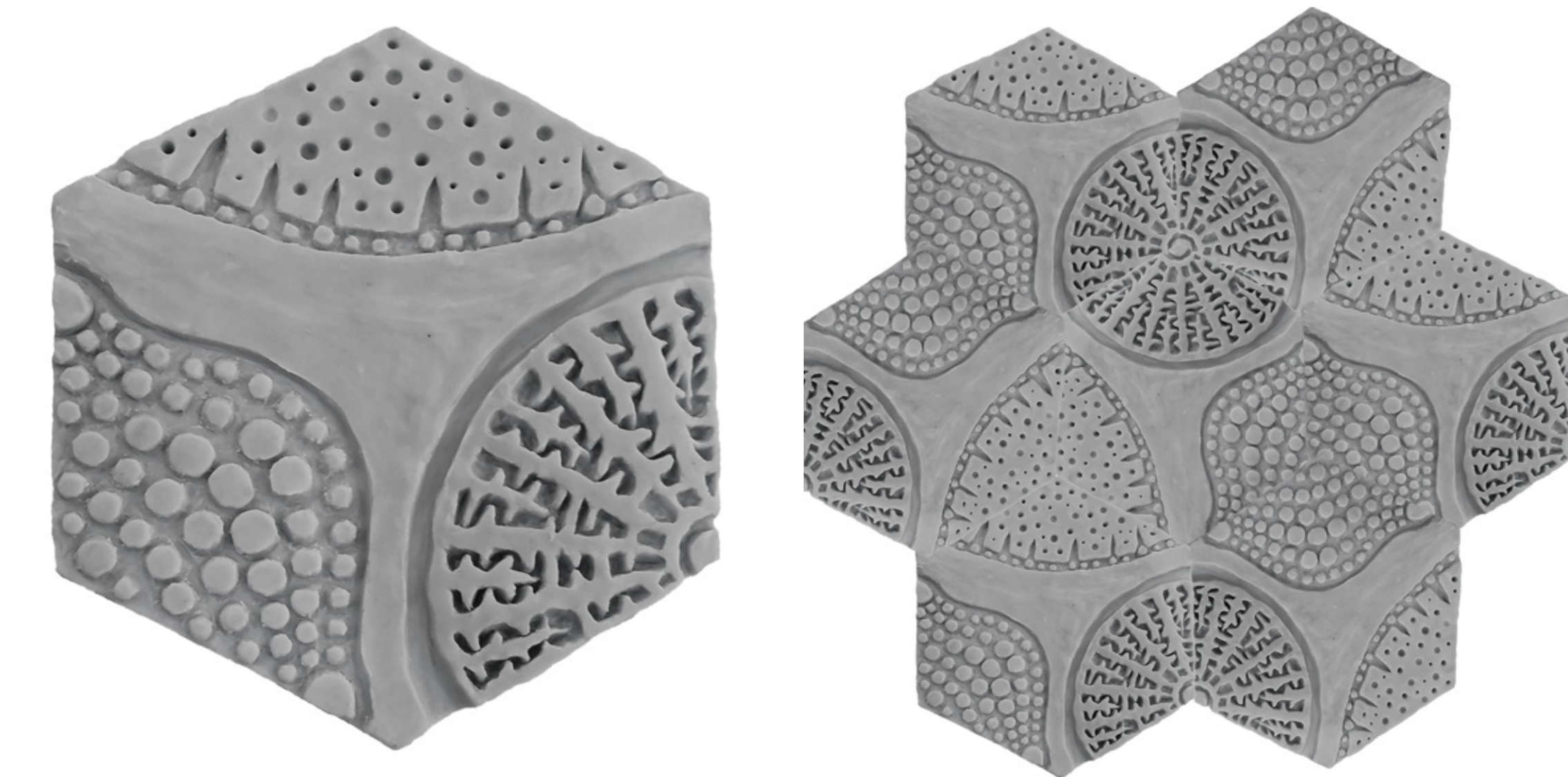

Diagram showing how each single paver fits together to create the overall pattern



Testing out a possible cast pattern: example of a single paver and then the set of seven it takes to make the entire pattern.



Each side holds one third of a diatom

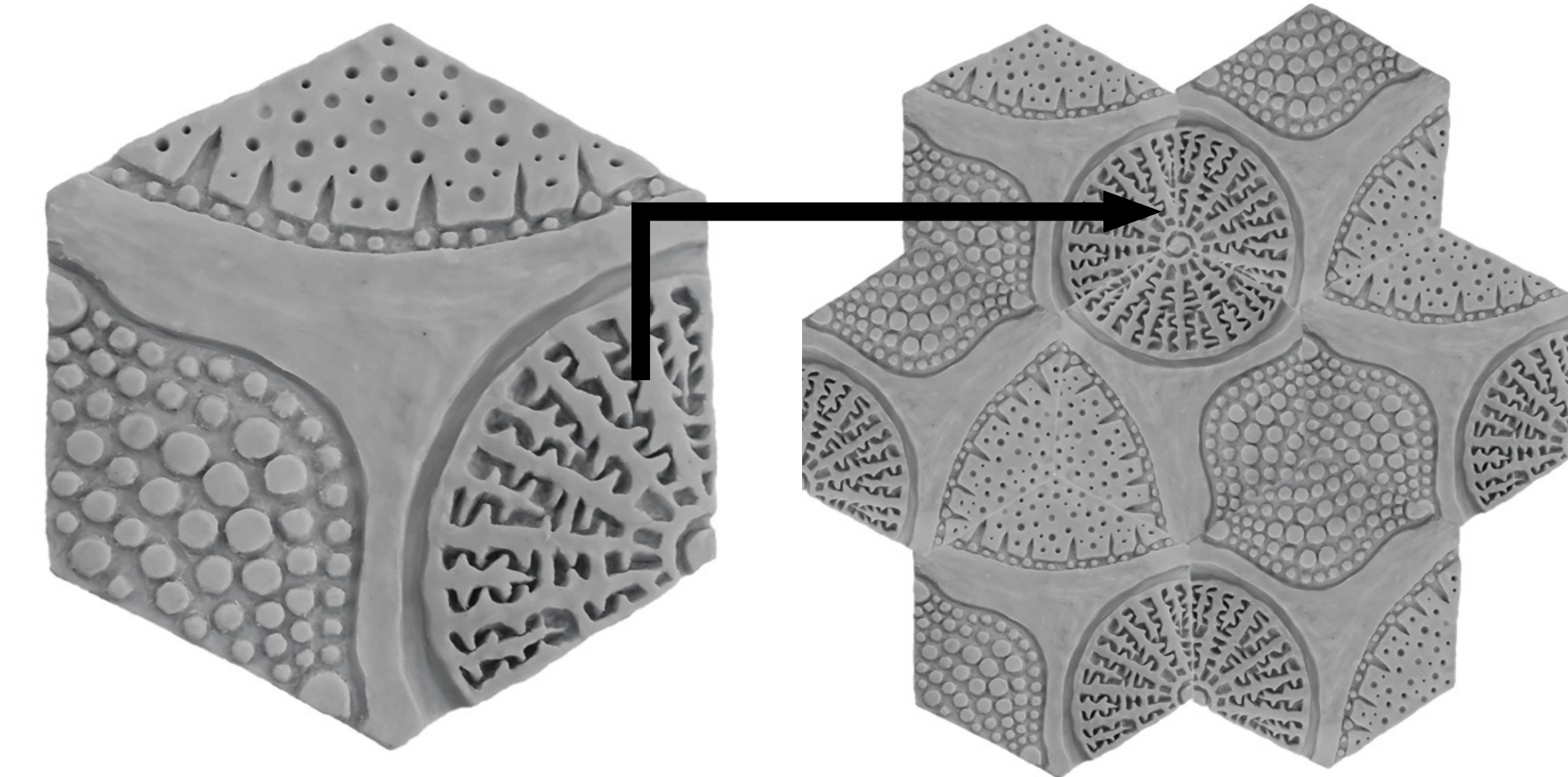

Cross-section showing the top surface of the paver and how it complies with ADA Standards of no more than 1/4 inch in depth

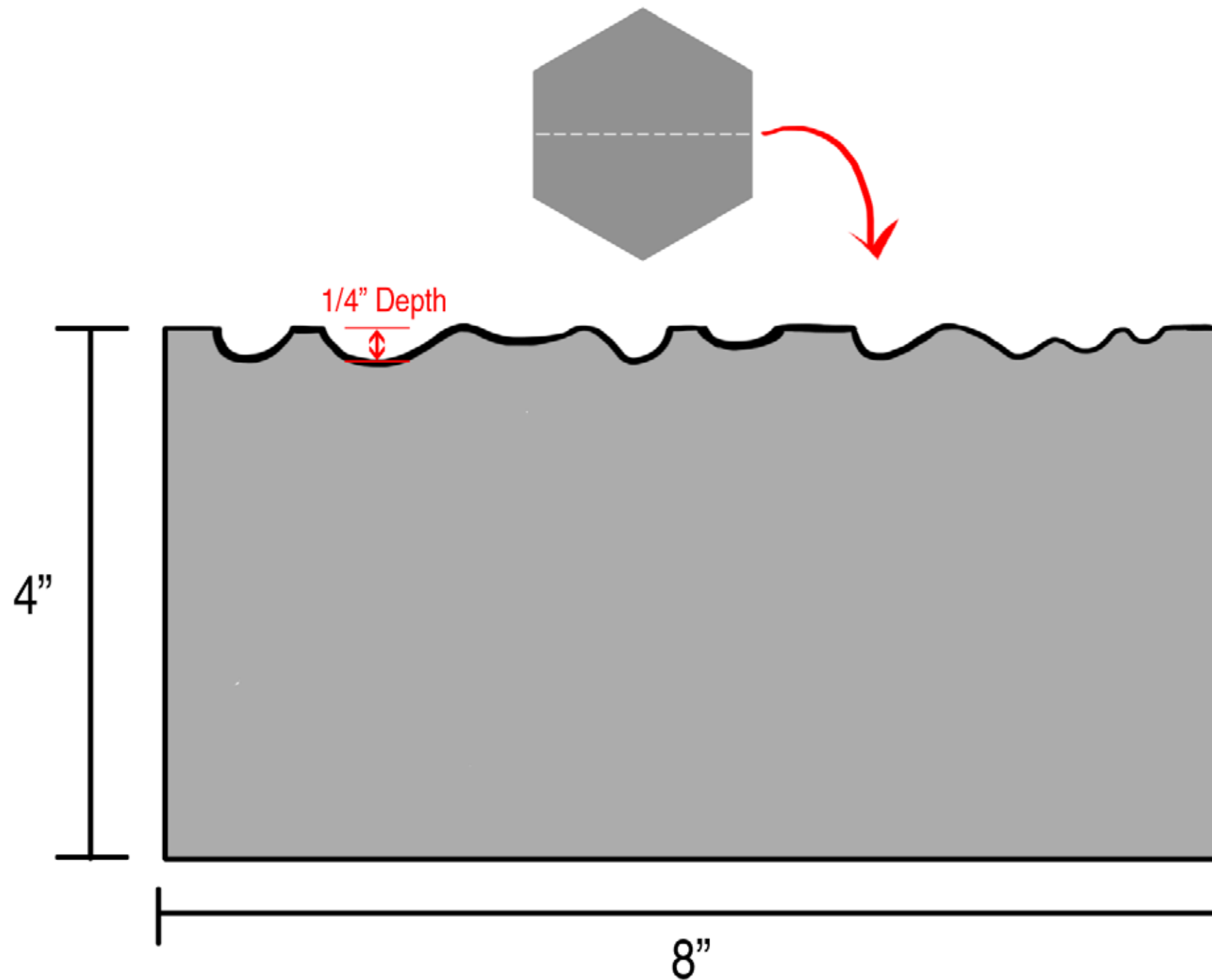

Looking south at Node with cluster pattern pavers



Investigating many possible configurations of diatoms and how the pavers join together to make an overall pattern

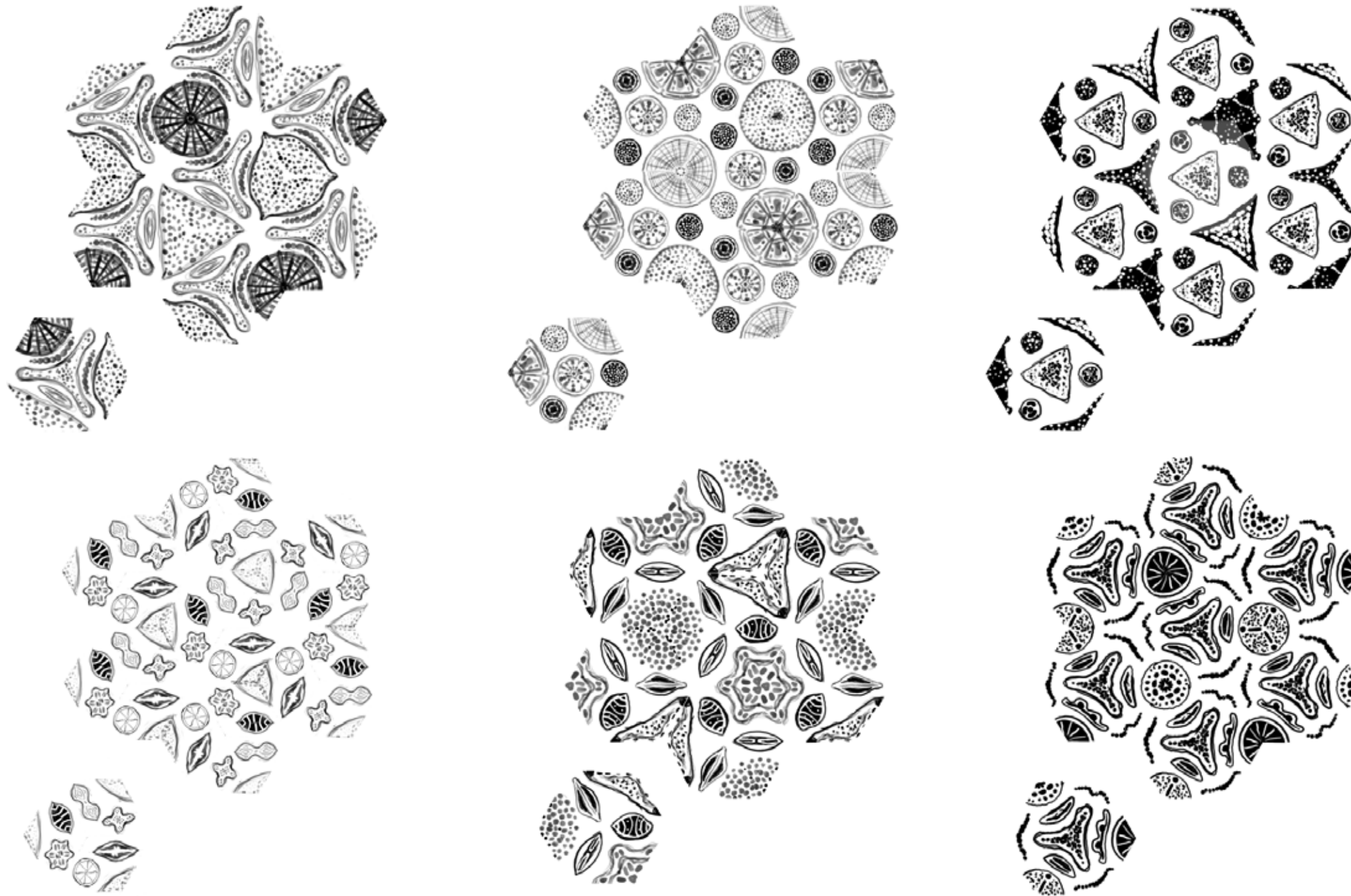

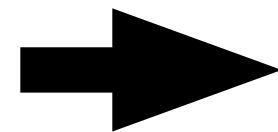

<u>Task</u>	<u>Date</u>
Invitation to Artists	December 8, 2017
Artist Submissions Due	January 12, 2018
Public Art Meeting #1 (Preliminary Selection)	January 30, 2018
Artist Orientation	February 8, 2018
Artist Charrette	February 26 and 27
Public Art Meeting #2 (Artist Presentation and Interviews)	February 28, 2018
Conceptual Design	Spring 2018
Preliminary Design*	Summer 2018
Final Design*	Fall 2018 / Winter 2019
EMG Construction Start	2019
EMG Construction Completion	2022

***Review with CB6 and CB8**

Project Website:

www.nycedc.com/project/east-midtown-waterfront

Project Email Address:

EastMidtownWaterfront@edc.nyc

Contact:

Morgan Jones, Government & Community Relations